

The Ladder Trap



Check out the video "how to build a ladder trap" on the BASC films website - basc.org.uk/films

Shopping list:

- 2.4m x 25x38mm tanalised tile lath (x30)
- 25mm rabbit mesh (25m)
- 50mm (2") screws
- staples
- cable ties
- 3" butt hinge (x2)
- Hasp and staple + small padlock

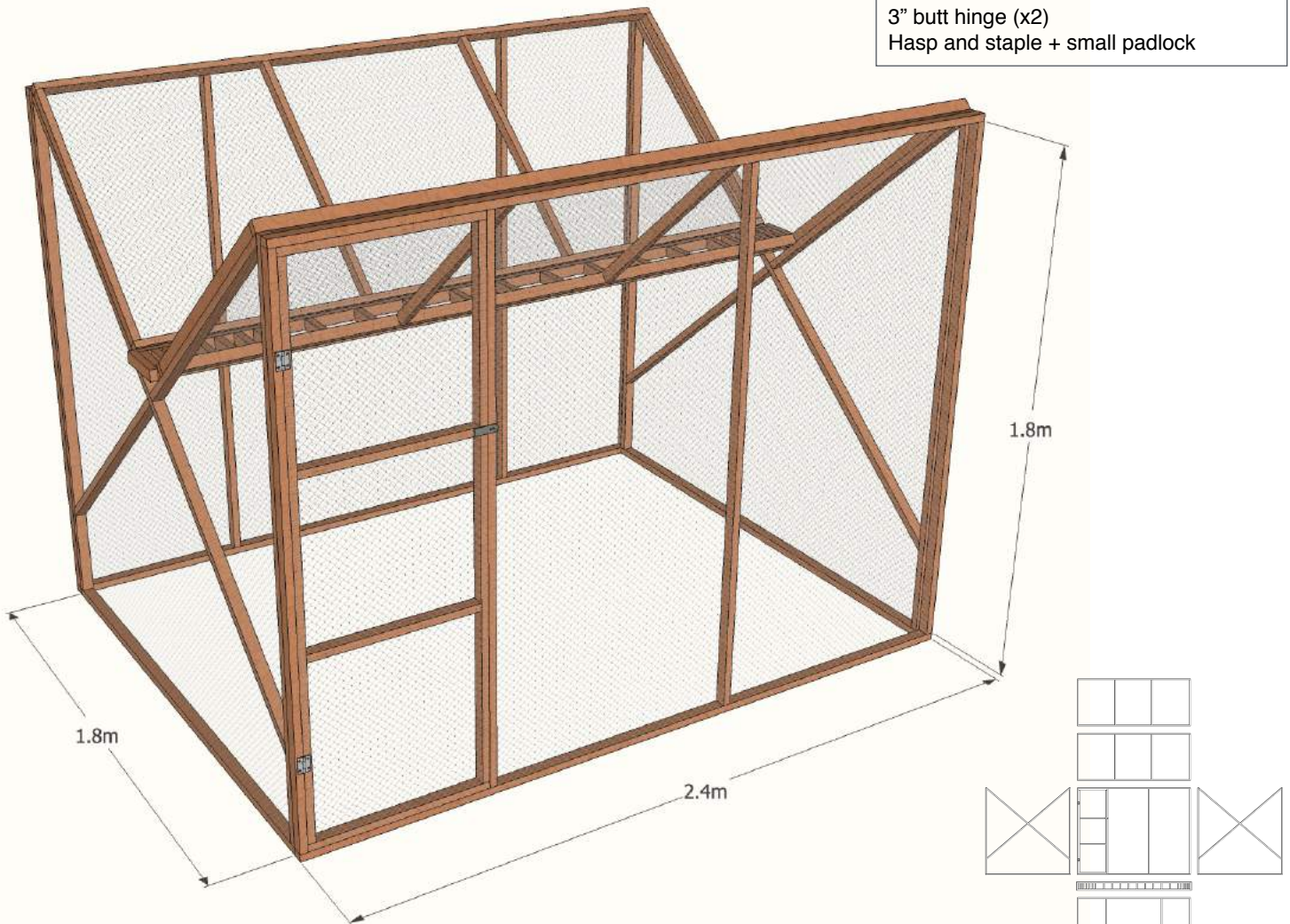

This design will make an average sized trap. Dimensions are based on standard 2.4m lengths of timber. Adjust dimensions to requirements.

Rooks and Crows 150mm

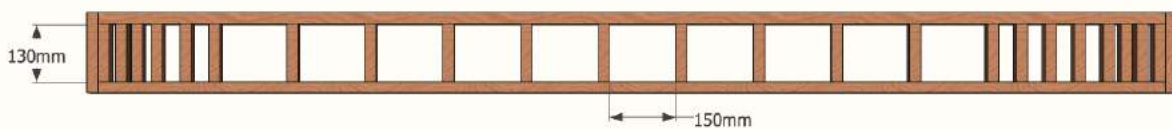

Jackdaws and Magpies 75mm

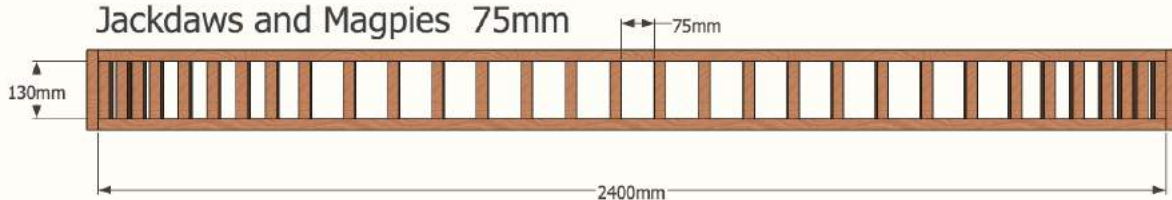

1

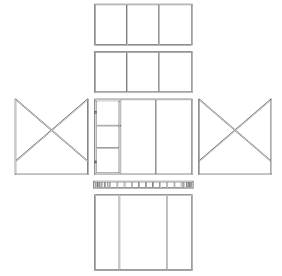
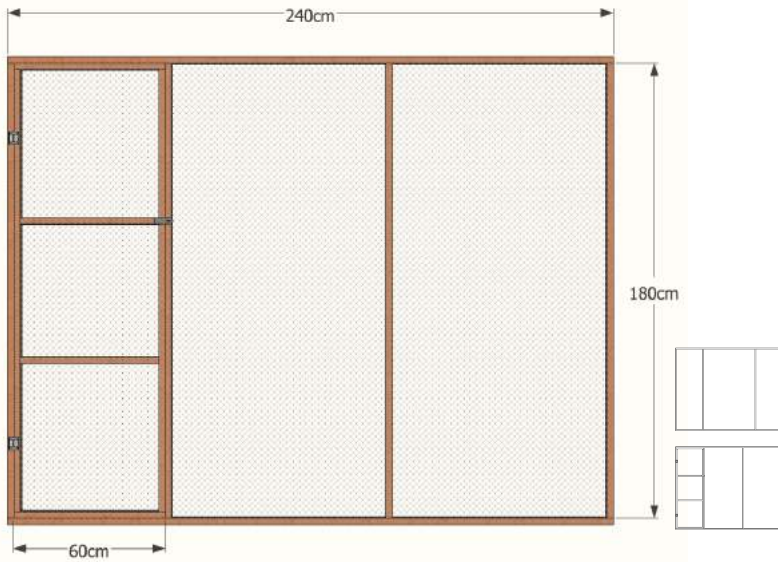

Side Panels

Attach hinges so door opens outwards.

2

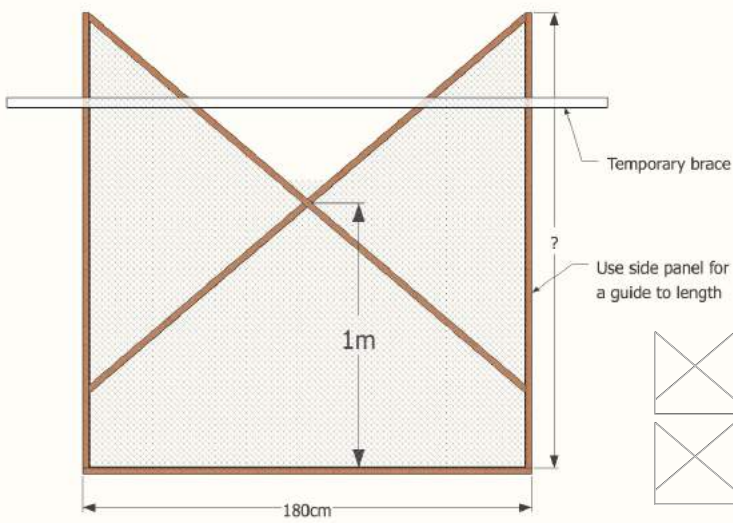

End Panels

A temporary brace will help keep frame square while attaching cross-members.

Ensure distance from base to cross-over is at least 1m from ground

3

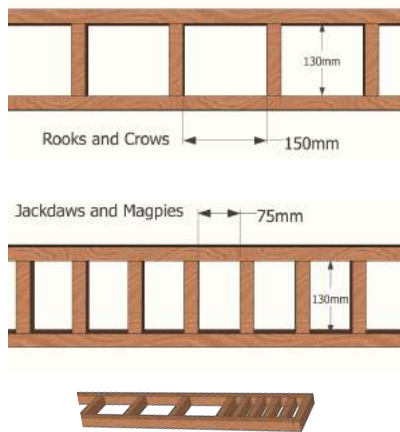

Ladder

Blank off the first and last gap of the ladder to prevent any birds climbing up the sides of the trap and escaping.

Regardless of the overall size of trap, rungs should be 130mm long and 150mm or 75mm apart, depending on target species (build two ladders!). Also see diagrams on the front page.

4

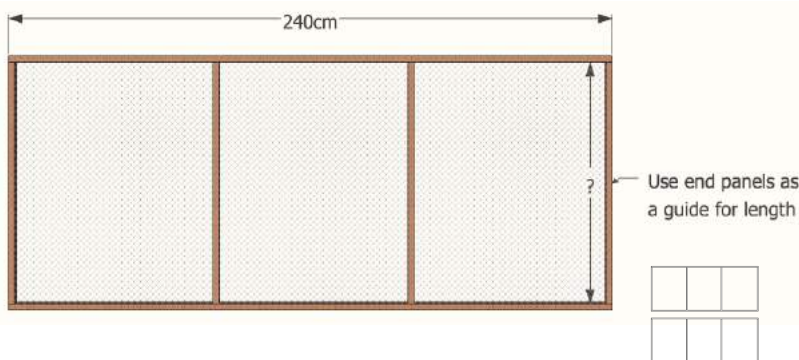

Roof Panels

Tip: Construct trap, fixing together with cable ties and use it as a guide to determine the length of the short sides of roof panel.

